

Ind. 0 - Revision : 07-2004

2TREu25 140x59R P/N C48-A8

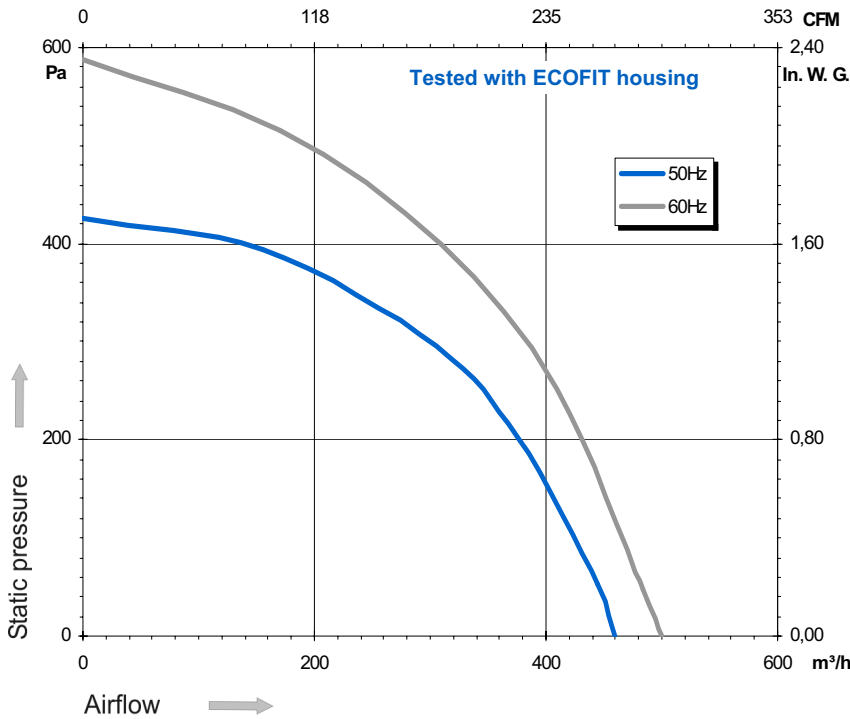

Voltage	Frequency	Input power	Current	Capacitor	Airflow	Speed rotation	Noise level	Rotation direction	Operating temperature
V	Hz	Wa	A	µF	m³/h	RPM	dBA	↻	Min / Max
115	50	182	1,59	16,0	510	2 210	65	R	-40°C / +70°C
115	60	219	1,91	16,0	500	2 135	64	R	-40°C / +70°C

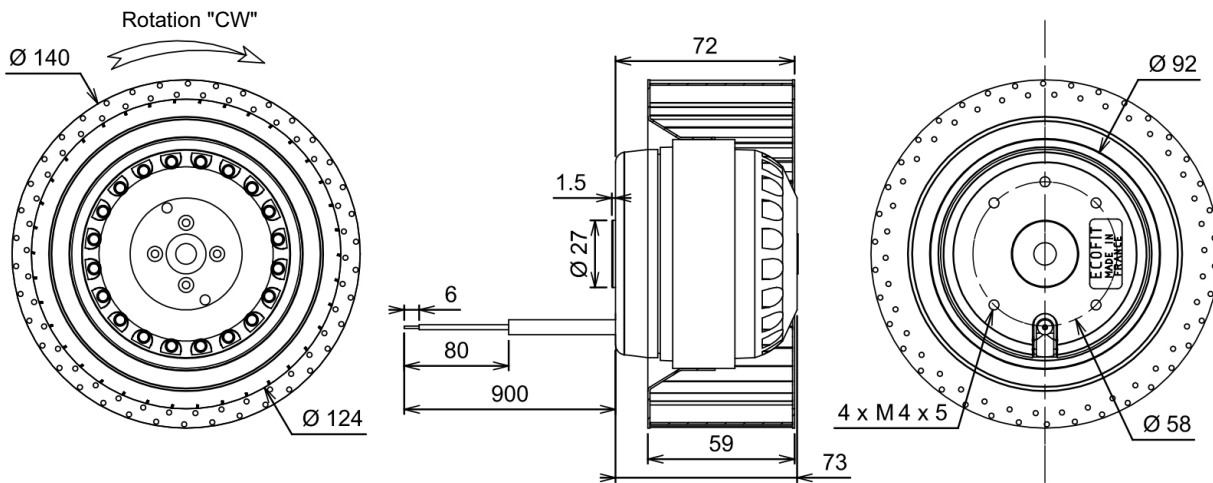

- Ball bearing
- Class F, thermally protected
- IP44 protection
- G2.5 balancing
- Galvanized steel impeller
- Rotor : black paint
- UL approved motor

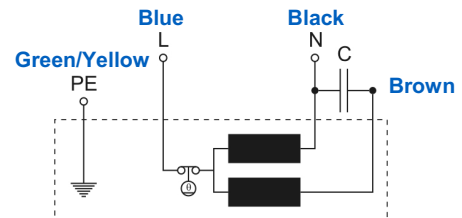

Capacitor for 50Hz	Capacitor for 60Hz	Zinc Coated	Inlet cone
19251-0	19251-0	21325-0	16043-a

Non contractual document. All specifications are subject to change without prior notice. Picture for information only.